

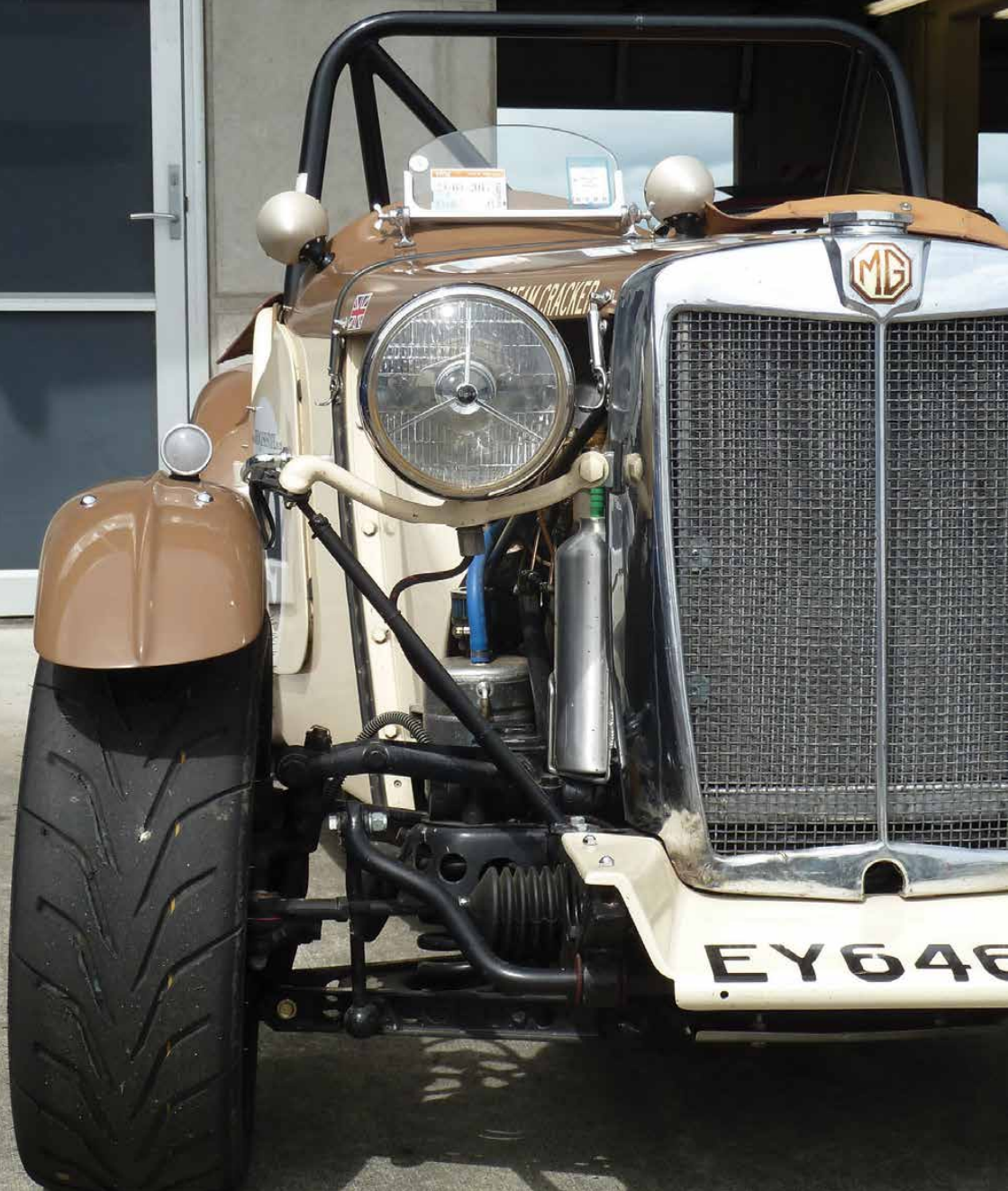

# Bulletin

PO Box 3135, Wellington, NZ. Dec 2016 - Jan 2017







MG Car Club (Wellington Centre) Committee				
Patron	Home	Work	Cell	E-mail
<b>President</b> Paul Chipp	04 586 8262	04 576 1500	027 248 3430	paul@netclinic.co.nz
<b>Vice President, Treasurer &amp; Membership Officer</b> Jim Higgins (Judith)	04 476 8967	04 476 8967	021 963 268	jhiggins@netedge.co.nz
<b>Captain</b> John Grant (Phillipa)	04 233 1082	04 233 8009	027 668 5591	j.p.grant@xtra.co.nz
<b>Secretary</b> Helen Cox (Michael)	04 297 2279			upnzway@earthlink.net
<b>Regalia</b> Michael Shouse (Helen)	04 297 2279	04 560 9426	027 419 8017	upnzway@earthlink.net
<b>Committee Members</b> Denis Christiansen (Margaret) Richard Whitehead (Belinda) Ron Robertson (Naomi) Jane Hector (Barry) Dean Gray	04 569 7480 04 235 8928 04 564 8389 04 562 8108 04 232 9422	04 569 7480  04 232 9422	027 644 4427  027 443 9969 027 246 6034	denis@mgcarclub.org.nz richardw1953@gmail.com ron@mgcarclub.org.nz jayhector70@gmail.com editor@mgcarclub.org.nz
<b>Pre '56 Contact</b> George Walter	04 478 0608	04 385 1892	027 438 9133	gwalter@clear.net.nz
<b>Scrutineers</b> Ron Robertson (Naomi) Ray Hartley	04 564 8389 04 384 4459		027 443 9969	ron@mgcarclub.org.nz
<b>Bulletin Editor</b> Dean Gray	04 232 9422	04 232 9422		editor@mgcarclub.org.nz

MG Classic Motor Racing Committee, PO Box 164, Wellington.				
Ron Robertson (Naomi)	04 564 8389		027 443 9969	ron@mgcarclub.org.nz
Paul Chipp	04 586 8262	04 576 1500	027 248 3430	paul@netclinic.co.nz
Ross Armstrong (Anne)	04 232 4175		027 443 8826	arfmg@mgcarclub.org.nz

Regional Contacts			
Auckland Centre	Paul Walbran	09 817 8194	paul@mgparts.co.nz
Canterbury Centre	Shirley Johnson	03 332 5776	johnsonsd@xtra.co.nz
Hawkes Bay			
Manawatu	Gay Baxter	06 322 0978	mg.baxt@xtra.co.nz
Mangaweka	John & Viv Eames	06 382 5717	mangaweka@hotmail.com
Otago Centre	Russell Walker	03 454 5347	russellwalker15@gmail.com
Taranaki	John Chambers	021 336 135	john.chambers@xtra.co.nz
Wairarapa	Brian & Julie Pope	06 377 1285 027 496 9036	bjpope@xtra.co.nz

Cover: MG Classic Motor Race: Grant Kern's 'Cream Cracker' MG TD race car.

Inside Cover: Old Speckled Hen 2016 Tour to East Cape:

Top: Cars lined up at Mohaka Viaduct. Photo: Michael Anderson.

Bottom: Team photo at Ohope Beach sadly minus Bill and Rae. Photo: Andrew Weeks.



## Coming Events

Mon 23 Jan	Drivers Training day at Manfeild - See page 31. Contact: Ron Robertson, details will be confirmed by email.
Wed 1 Feb	Noggin N Natter - Waterloo Bar & Grill, 27 Waterloo Quay, Wellington. Contact: Jim Higgins, details will be confirmed by email.
Sun 12 Feb	British Car Day - Trentham Memorial Park, Barton Rd, Heretaunga. British Car Club - Admission for display vehicle - \$5.00
Mon - Sat 20 - 25 Feb	MGCC Pre 56 Rally - Wanganui. Contact: Michael Anderson - email: michael.anderson@xtra.co.nz
Wed 22 Feb	Club Night Dinner, Jackson Cafe & Bistro, 306 Jackson St, Petone. Contact: Michael Shouse, details will be confirmed by email.
Thurs 23 Feb	Old Speckled Hen Run - Murrayfield Langdale Café & Restaurant, Levin. Contact: Michael Anderson - email: michael.anderson@xtra.co.nz
Sat - Sun 25 - 26 Feb	MGF/TF Festival - Mangaweka - See page 16. Contact: John & Viv Eames - email: mangaweka@hotmail.com
Sun 5 Mar	Southward's Car Museum open house, Paraparaumu - Start time 9am. MGCC car display, Admission for display vehicle - \$5.00.
Sun 5 Mar	Turatara Brewery pizza dinner, 7 Sheffield Street, Paraparaumu. Start time 3pm. Contact: Michael Shouse.
Sun 12 Mar	Noggin N Natter - MG garage visit & quilting session - See page 37. Contact: Michael Shouse, details will be confirmed by email.
Sun 26 Mar	Big Breakie Run to The Dish, Masterton & The Vintage Aviator Fighter Collection after, details will be confirmed by email.
Thurs 23 Mar	Old Speckled Hen Run - To be advised Contact: Michael Anderson - email: michael.anderson@xtra.co.nz
Wed 29 Mar	Club Night Dinner - Yeay's House, 209 Main Rd, Tawa. Contact: Dean Gray, details will be confirmed by email.
Fri - Mon 14 - 17 Apr	MGCC Easter Rally, New Plymouth. Contact: Paul Walbran, MGCC Auckland - email: paul@mgparts.co.nz
Committee meetings are held on the first Monday of the month, 5.30pm, Meeting room, Wellington Bridge Club, 17 Tinakori Road, Thorndon.	



## Editorial



Since the last issue I have finished (for the moment, are you ever finished) the red MG, having repainted the roof. Plenty of positive comments. So I have finally moved back onto the green MG. The custom interior and dash has been reinstalled, the electrics tested, as to be expected there were a couple of circuits that required trouble shooting. I have still to install the engine, but I hope to have her on the road by Christmas. But that depends on a lot of ducks being in a row. *Have a safety fast Christmas and an enjoyable New Year.*



## Articles

Articles, letters and events write ups for publication in the Bulletin should be sent to [editor@mgcarclub.org.nz](mailto:editor@mgcarclub.org.nz).

Closing date is now the 20th of each odd numbered month, for publication in the following two monthly Bulletin, six issues per year.

Typed in the body of the e-mail or in a Pdf format attached to the e-mail would be great, but hand-written on anything clean is equally as welcome. Pseudonyms will be used if specifically requested, but please supply a name and address.

Committee members will each contribute a minimum of two per year by roster to ensure a 'wider editorial style'.

**Disclaimer:** The opinions expressed in this bulletin do not necessarily reflect those of the Club or the Centre Committee.



## Captain's Ramblings

Something I came across recently, I thought might interest you. Not only is it indirectly related to MGs, it also features some 'best of Britishness' with a 'Kiwi' flavour.

### Then...

About 60 years ago, Sir Alec Issigonis, doodled a car design on a café napkin in London.

The car he sketched was meant to be an urban car for the masses. In response to the Suez crisis, the Mini was designed to be frugal on fuel and smart on space, with a flat-out top speed of just 71mph. To quote 'Tui', Yeah right.

The car was launched in August 1959 as the Morris Mini Minor and the Austin Seven (which soon became known as the Austin Mini). The car was later simply called the 'Mini', went on to become the best selling British car in history.

### Now...

Earlier this year, Mike Wilson and Brian Hartley from Nelson took a 1964 Mini to the Bonneville salt flats in Utah. Sir Alec would have been well pleased when they broke the world land speed record for the petrol powered IB/GALT class, clocking over 144mph and then filled it up with methanol and broke a second world record. Magnificently mad men in their flying mini.



People with good memories for car trivia, will remember Nelson Hartley and his crew from 2012, when they set their first record. Now they have done it again and the world's taking notice – from obvious connections, to the likes of Burt Munro, to magazine covers, to featuring in Jay Leno's Garage show.

For some reason New Zealanders have always loved pocket rocket cars – from the classic Mini to the likes of the racing classes for Suzuki Swifts, and of course the bum-clenching Lotus 7 produced by the Steel Brothers in Christchurch.

### The MG connection?

Prior to designing and developing the 'Mini', Sir Alec developed an independent front suspension system for the Morris 10 while working at Morris Motors Ltd at Cowley. When the war prevented this design from going into production, it was later used on the MG Y-type.

With summer and finer weather on the way, happy motoring in your own rocket.

*John Grant*



## New Zealand's Maserati 250F Story

Club member and Bulletin contributor Terry Collier has written this fine book on the Maserati 250F in New Zealand. Terry offers the book to club members at \$25 + postage and packaging, normally \$35 retail. Contact Terry on - [terry.collier@clear.net.nz](mailto:terry.collier@clear.net.nz)



### Untangling the Mystery: New Zealand and the 250F Maserati

Terry Collier

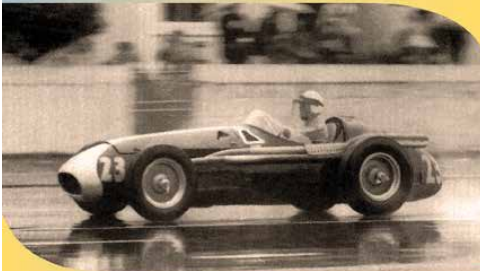

The 250F Maserati is one of the world's most recognisable Grand Prix cars.

It is also probably the one model that has collected more histories, legends, myths and stories than any other. These will continue to grow over time.

What is frequently overlooked in these various accounts and histories, however, is an account of the lengthy and significant part New Zealand played, not only with three of the foremost examples domiciled in the country, but also in its eventual phasing out as a competitive race car.

This history attempts to trace and document the story of the 250F Maserati in New Zealand and in particular the specific cars and drivers involved with them in the years between 1957 and 1962.

The account also places the cars in the context of other Maserati single seaters and 250Fs that appeared and raced in New Zealand in those decades.

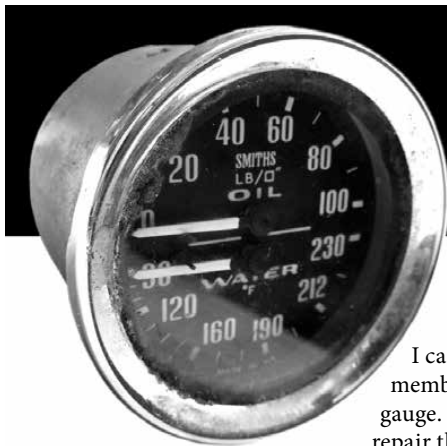

## FAULTY WATER TEMPERATURE GAUGE?

The Editor has acquired a source of diethyl ether and has successfully repaired two of his faulty Smiths capillary temperature dual gauges.

I can now offer a service to other club members. No charges if I fail to repair the gauge. Postage & packaging is extra or I can repair the gauge in the car if I have the car for a week. Contact the Editor on [editor@mgcarclub.org.nz](mailto:editor@mgcarclub.org.nz)







## 1995 MG F long-term test - Throwback Thursday

13 October 2016 - When the MG F launched in the autumn of 1995, it was met with much excitement from sports car enthusiasts. Being the first new car under the MG marque since the B of 1980, expectations were high.

On 18 December 1996, slightly more than a year on from the car's launch, Autocar's Allan Muir gave his verdict on 10,000 miles in the F.



“No matter what we end up thinking of the MG F, we should all be celebrating the fact that Rover has built this car at all,” Muir began.

“For years we've been crying out for an affordable British roadster to pick up where the MGB left off, and here it is – an all-new design with a pukka mid-engined layout, a terrifically rigid chassis, rear-wheel drive and state-of-the-art engines.”

The car's modernity brought its benefits, too. “The MG F puts as much emphasis on refinement, comfort and user-friendliness as it does on the driving experience,” Autocar proclaimed. “No longer do you need to be a hardened enthusiast or have the patience of a saint to put up with the hassles previously associated with an open-top car.”

The F that our man had been testing was the more sporting 1.8-litre VVC-engined model, costing £19,940.

Two options were fitted to the car. Firstly, the "marvellous" pearlescent Amaranth paint, at £315, which “appeared to change colour depending on the light”, and secondly the £1095 glassfibre hard-top roof, an option that was taken up by around half of buyers.

So, how had Autocar's long-term tester found the car after 10,000 miles?

“Apart from the inherent enjoyment to be had from driving with the roof down, it's the 143bhp engine that really makes the MG F. It has enough power to propel the car along at a decent pace and hide the wideness of the gear ratios – both problems with the basic [1.6-litre] 118bhp car,” Muir began.

Not only was the 1.8 engine in Autocar's F "fruity sounding", but it was also more free-revving for its mileage, and gave a respectable 33mpg average fuel economy.

It was practical, too: “Although the cabin is quite narrow, it's easy to enter and exit and is a comfortable place for two people to spend time, while the boot is big enough for squishy bags.”

Being a Rover Group car, though, there were some inevitable pitfalls.

“The main source of frustration is the heater and ventilation system, which has proved painfully inefficient,” we lamented, because “the demister is slow to clear the windscreen and the temperature control seems to consist solely of maximum heat (which soon sears





## 1995 MG F long-term test - Throwback Thursday

the eyeballs) or cold. Visibility is restricted for too long on cold mornings.”

In fact, our man found driving with the soft-top up to be the least desirable mode.

Then it was onto the roadster’s looks.

“Pretty’ is the adjective that springs to mind,” said Muir. “The MG F is a little effeminate and lacking in aggression for my liking. It’s at its best in wacky colours like that of our car, and on the five-spoke alloys.” The hard-top was one of the best looking of its type, too.

Two things went wrong during the car’s time with us: a rattling hard-top, which had a new seal fitted under warranty, and a restrictive air intake hose on the engine, which was replaced with a harder one by MG, free of charge.

Most important for a car like the F, however, were the driving dynamics. The MG wasn’t all rosy, though: “Rover has trodden a safe path with the MG F’s handling,” we began. “It behaves more like a front-drive hatchback than a mid-engined roadster.

“By most standards, the MG F is a pleasant-handling car. Its rigid chassis resists scuttle shake to an impressive degree, while grip and poise are hard to fault.

“However, a combination of too much weight, sluggish turn-in and unwavering understeer can make it feel a little unwieldy on twisty roads. And all the major controls – steering, brakes, gearshift and so on – feel heavily damped and remote, not involving the driver enough.”

For comparison, we didn’t feel the car to be as agile or entertaining as a Peugeot 306 GTi-6, or especially a Lotus Elise.

It wasn’t amazing on the motorway, either, with the driver needing to make lots of small corrections to keep it in a straight line. “Throw in the fact that the engine is working quite hard at motorway speeds and that the car isn’t as quiet as a tin-top and the MG F can be a demanding companion on long motorway hauls,” we said.

Overall, though, it was an enjoyable car, with Muir concluding: “A pleasant and mostly undemanding way to enjoy open-top motoring, but it needs more attention to detail. Rover has declared its intention to develop the MG F. Yet more good news for roadster fans.”

Develop it they did, with the car being upgraded to Mk2 guise in 1999, before its eventual replacement in 2002 with the launch of the TF.

*by Kris Culmer, [www.Autocar.co.uk](http://www.Autocar.co.uk)*

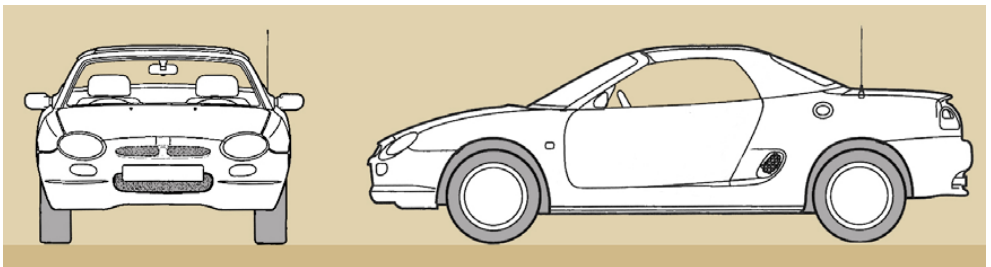



## Old Speckled Hen Run – September

Old Speckled Hen 2016 Tour to East Cape:

### Thursday 27 October

Our adventure started from Waikanae with the following participants:

- Michael & Elaine Anderson: **MGBGT**
- Bill & Rae Denize: **MGZR aka Scruffy**
- Helen Gillbanks: **MGF**
- Ron Mitchell & Shirley Kelly: **MGTF**
- Les & Chris Newman: **MGB Roadster**
- Chris & Wendy Ward: **MGBGT**
- Andrew & Jill Weeks: **BMW Z4**

were joined at Woodville by

Rob & Sandra Illingworth: **MGBGT**

and at Taradale by:

John & Viv Eames: **MGF**

Seventeen intrepid travellers all determined to enjoy this event set off for Taradale. The weather had been inclement over the past few days but the forecast had given us all some hope for the day. As we left home the weather Gods were smiling: a blue sky and plenty of sunshine.

We departed from Waikanae, heading north on SH1, regrouping after turning right onto the Shannon Road. By the time we passed the fork for Palmerston North the traffic had thinned out and we were all able to thoroughly enjoyed the swooping nature of the roads and the very pleasant countryside. As we headed towards the Manawatu Gorge we witnessed some dreadful driving. Our party was travelling close to the speed limit when we were passed by a Land Cruiser, complete with trailer, travelling at least 30 kph over the speed limit. Not to mention passing on yellow lines!



Relaxing at the Colonial Motor Inn, Taradale



## Old Speckled Hen Run – September

I think that the whole party was pleasantly surprised by our lunch stop: the Nibbly Pig Cafe at Woodville. Great atmosphere, good food and spotlessly clean - what else could you hope for? After Woodville we took SH50 directly to Taradale to our overnight stop: the Colonial Motor Inn. Here it was good to catch up with John and Viv Eames who had been lucky enough to arrive from Mangaweka via the Gentle Annie. A very pleasant hour with nibbles and drinks started the group bonding before enjoying an excellent and cost effective dinner at the RSA next door to the motel. As we left the RSA, several of our group waited as a quiz was taking place. The conveyor looked amazed as we advised that we had got 17 correct answers as we left!

### Friday 28 October

A leisurely start today giving everybody time to enjoy a good rest and time to get the cars refuelled. Once again the weather was good and several of the hoods were lowered. We commenced the splendidly scenic run from Hawkes Bay to our lunch stop at the Osler Bakery in Wairoa. What a run. We travelled in a loose convey formation. Michael Anderson in his MGB GT led the way, followed by a further two BGTs and a B roadster. They were followed in turn by the MGT Anniversary and two MGFs: our Z4 followed with the MGZR acting as tail end Charlie. As we climbed out of Hawkes Bay the roads seemed to be quieter and we luxuriated in the sight of seven MGs on the road ahead of us, the image of Bill's MGZR prominent in our rearview mirror and little else to be seen. The smells and aromas of the spring countryside were abundant, several pleasing to the nostrils, whilst others were nothing short of an assault on the senses. This was MG motoring as it should: we were collectively in heaven.



Mohaka Viaduct



Millton Vineyards & Winery

Yet again we witnessed some awful driving. We watched the MGZR through the rear view mirror as Bill coped manfully with a Ford tailgating him for miles. He eventually got past and repeated that performance right through the field of MGs. One doesn't object to making way for faster traffic, but in my book, tailgating is an absolute no-no!

At our well chosen lunch stop, it was no surprise to see that most of our party got into the prize-winning Osler pies. They were gorgeous. Then it was back onto the road for another saunter through gorgeously green countryside and our next stop at the Millton Vineyards & Winery. Here we not only tasted (and purchased) some pleasant wines, but had the

# Old Speckled Hen Run – September

benefit of an excellent address from the Proprietor about their long term efforts in organic wine production. Our day ended with a lovely dinner at the USSCo Restaurant, next door to our motel as yet another excellent day came to a successful end.

## Saturday 29 October

Our planned rest day in Gisborne started with several of our party visiting the local farmer's market. Produce not only looked good but was very competitively priced. Coffee shops were sampled, retail therapy undertaken and some took the opportunity to visit the Eastwoodhill arboretum. The highlight of the day was the opportunity to have drinks and nibbles with Les and Chris Newman before heading to dinner and a meeting with the local MG group at the Works Restaurant. As you would expect, old friendships were renewed and new acquaintances forged - just as you would expect within the MG family.

However, today will long be remember for the disaster that struck this morning. Sadly Rae Denize fell in town, breaking her right arm and severely spraining her left leg. There was no alternative, but to get her home as quickly as possible. Inevitably Bill will also be lost to the the tour. Rae, Bill and Scruffy will be sadly missed. However all our thoughts are for Rae to have a rapid and complete recovery.



Taking Lunch



Gisbourne

## Sunday 30 October

The weather has finally broken with heavy rain overnight. We were all pleased that Rae Denize had experienced a good night before we made our fond farewells. Heading north from Gisborne we travelled in convoy to for our morning coffee. The road north proved to be an absolute delight: swooping curves and very little traffic - just as it should be.

From this point onwards we proceeded independently to our overnight stop at Hicks Bay. There were plenty of historical sites to visit ranging from abandoned Freezing Works, old wharves, delicately decorated churches and Wakas in fields. Many of our party drove into Ruatoria with a view to seeing the old bank building in which Bill Denize has worked some fifty years ago: but to no avail. Thereafter it was a case of finding a coffee shop to augment our picnic lunch, taken beside a small lake together with Les and Chris Newman.

Thankfully such an outlet was found albeit close to Hicks Bay: at the Manuka Honey farm shop . Our day ended with a set meal at the Hicks Bay Motel. Good wholesome food served





## Old Speckled Hen Run – September

by some lovely staff all the while enjoying an excellent banter covering topics as diverse as MG cars to the electability of Donald Trump! We had had a lovely drive in less than excellent weather conditions. Tomorrow holds the promise of both a full English breakfast and much better weather. Things are looking good once again.

### Monday 31 October

A hearty breakfast and a clear sky gave our day the perfect start. It was a very special day for two of our party, Christine Newman and Shirley Kelly, both of whom were celebrating their birthdays.



Wharf at Tolaga Bay



Derelict building Tokomaru Bay



Wharf at Tokomaru Bay

Much amusement was gained from Shirley, who acknowledged being twenty one again, as she advised that between Ron and herself, their combined ages was a little under 160! Ron looked remarkably good for his age!

After the driver s briefing we set off individually for the run around the top of East Cape, agreeing to meet at Opotoki for lunch. This was just perfect driving conditions. Virtually no traffic on what can only be described as a driver s road made our journey idyllic. The top of the East Cape and the western side features the Pacific highway clinging to the coastline. It is both beautiful and dramatic. We were given multiple perspectives of White Island belching away in the distance. This really was New Zealand driving at its best: virtually empty roads with empty logging trucks going the other way heading for a new load.

Jill and I were rather taken with our excursion through Waihou Bay. Not a lot of homes, but all well kept with gardens and lawns neatly presented: it spoke well of the community. A few kilometres further on was a lovely white church by the sea with White Island in the background. Inside the church showed its strong Maori community connections and was a delight to witness. We were taken by the high number of visitors from Germany that had signed the visitors book. There were a German couple



# Old Speckled Hen Run – September



The Birthday Girls

at the church driving a Juicy Campervan. They talked about the cars, but were quick to point out that in Germany the value of the BMW Z4 was dropping whilst the value of vehicles like Chris and Wendy’s MGB GT was increasing!

Coffee was finally found at a very pleasant cafe at Te Kaha before we headed to Opotoki for lunch. The drive onwards to Ohope Beach was relatively easy after the windy roads of East Cape. We stopped at the top of the hill, just before Ohope Beach and visited the Tauwhare Pa site. It was quite a climb but well worth it as the views over the salt marshes and sea were delightful.

At our motel we had a splendid BBQ expertly cooked by Michael, Les and Ron with Elaine & Wendy doing a wonderful job with the salads. Yes the weather did break and we had some rain, but it had virtually no impact. We rather liked the photo of the resultant rainbow apparently ending on the roof of Michael and Elaine’s MGB GT: sadly we didn’t find a pot of gold!



Sadly no pot of gold

The BBQ featured three highlights:

- Birthday wishes and birthday cake for Christine and Shirley;
- A speaker-phone link up with Bill Denize now safely home in Wellington;
- and An overwhelming consensus that Michael had done a wonderful job with this OSH run and that it must be repeated again next year.

## Tuesday 1 November

We bade our fond farewells to Chris and Wendy Ward, John and Viv Eames and Helen Gillibanks before heading for Whakatane. Only a few kilometres away, we were transformed from an idyllic beach/holiday environment into a rural town setting. The views from the river estuary were lovely and the town seemed to be prospering. The roads from here to Rotorua and Taupo were more crowded than those around East Cape yet the scenery was almost as breathtaking. Rolling hills, lakes and good farming countryside complemented the fine roads.



## Old Speckled Hen Run – September

Once in Taupo, we met up with Helen and Chris Kirk-Bernnard at their holiday home in Acacia Bay. Here we were treated to nibbles and drinks and the opportunity to have a good look at their two MGs: a 1959 MGA that he has owned for 40 years, duly rebuilt by Brayshaws, and a delightful 1933 MG J2 Midget favourably known as Kermit. Both cars are used and live at the Taupo home.



Chris Kirk-Burnnard and the  
1933 MG J2 Midget



Jill Weeks looks happy in the 1959 MGA

Our final dinner was held at Jolly Good Fellows on the Taupo waterfront where we were pleased to be joined by Chris and a Helen. One sensed that the overriding sentiment was that the run had gone far too quickly. Proof positive that participants were enjoying themselves.

### Wednesday 2 November

Today we have rain. Clearly the weather Gods were not smiling: no doubt lamenting the fact that this was our final day on the run. We traveled in convoy from Taupo to Taihape for lunch at the Cafe Telephonique which was as good as ever. Despite the conditions, it was a excellent run managed in good time. We were led by Rob Illingworth who managed the convey with aplomb. We were pleased to once again catch up with John and Viv Eames at our lunch stop before fond farewells were made and we separated for the run home.

### Final reflections

This has been a simply wonderful Old Speckled Hen run. We have covered a little over 1,540 kilometers (Waikanae to Waikanae) over seven days, enjoying a plethora of differing sceneries and road conditions. As you would expect, there has been neither a cross word nor a single complaint, highlighting what a fabulous job Michael and Elaine Anderson have done of the organising and management of this event: not to mention the expected camaraderie and contributions of the participants. I am certain that I speak for all participants in extending our thanks to Michael and Elaine and sincere hope that they will do another similar event in 2017. Miss it at your peril!

*Andrew Weeks*

*Photographs: Andrew Weeks & Les Newman*





## WSM Sprite



Not small, just fun-sized: Just 14 of these pretty Sprite-based GT coupes were produced. Italy's carrozzerias were renowned for crafting beautifully shaped sports car bodies out of hand-formed aluminum, but in England, where the burgeoning sports car and racing specialists were doing the same, their material of choice was usually fiberglass.

One particular sports car specialist was Douglas Wilson-Spratt, the owner of an Austin dealership. Douglas, like many other enthusiasts, longed to produce his own sports car, so he teamed up with Donald Healey's London sales manager, Jim McManus, and together they formed The Healey Centre. Based in London, they specialized in servicing Austin-Healeys and doing high performance tuning for those owners seeking more power. Within a short period they built a one-off fastback coupe using a Sprite as the foundation; combining their last names they called it the WSM.

Looking somewhat like a 250 GT SWB Berlinetta Ferrari from the rear, the WSM Sprite was a very attractive little sports car. Like other Sprites, it was powered by the A-Series Austin four-cylinder engine of either 948/1098/1275cc. Fitted with a lightweight aluminum







## WSM Sprite

body and a forward-tilting fiberglass bonnet, the little sports car weighed just 1,100 pounds, and with an engine putting out close to 100 horsepower, its performance was quite electrifying.

For such a great looking sports car, only 14 examples were produced, with the car you see here being the only example in the United States. This WSM beauty is owned by renowned Austin-Healey collector and historian Bill Emerson. As the former owner of an ultra-rare Austin-Healey 100S, a 1946 Healey Westland and various Big Healey models, Bill is also the author of *The Healey Book*, a large, hardcover book that profiles all the different Austin-Healey models – and boats. Bill was fortunate to know the builders of the WSM and bought the car directly from them just a few years ago. A full-length story on this fascinating little sports car will soon appear in *Hemmings Sports & Exotic Car* magazine.

Richard Lentinello - May 2016 - [blog.hemmings.com](http://blog.hemmings.com)



## MG Gisborne Newsletter

Hi Crew,

- The Wellington and Manawatu MG members arrived in Gisborne late Friday the 28th October and met with the Gisborne MG group members (7) for dinner at the Works on the 29th. A pleasant evening was had by all with the Works providing nice mains and deserts to experience. There was 16 visitors present with a variety of cars: MGfs, MGtf, MGBgts, MGzr and a BMWz4 roadster 9 cars in all.

In a nice gesture the Wellington Club rep Michael Anderson presented the Gisborne Group members a monogram printed up with the Old Speckled Hen English Fine Ale on it. The history to this is that it is a MG drink as the Old Speckled Hen was one of the early MG cars named at Abingdon. We have found that Countdown stocks it but not here in Gisborne. It will be looked into further as the Wellington Club carries out Old Speckled Hen runs.

Sadly Bill Denize's wife Rae tripped over at the markets and broke her elbow and injured her ankle thus being unable to attend the evening. We wish her a good recovery.

GISBORNE MG GROUP issue 4



## MGF/TF Festival - February 2017



### **Mangaweka MGF/TF Festival Firmly Established**

With the 4th MGF/TF Festival coming up at Mangaweka on 25/26 February 2017 the event is now firmly established on the MG calendar for the last weekend of February.

Mangaweka and Awastone Riverside Haven offer an impressively scenic and laidback venue for such an event.

The gathering specifically for these nifty little cars is the perfect opportunity for owners to socialise, share ownership experiences and gain valuable advice for the successful management of their cars.

If you own an MGF or TF, mark your calendar for Saturday 25 and Sunday 26 February 2017.

For full entry information and accommodation options contact:

John & Viv Eames

Email: [mangaweka@hotmail.com](mailto:mangaweka@hotmail.com)

Phone: 06 382 5717

Mobile: 027 782 5717



## Story of Petrol

WHO discovered petrol? A good question, like who invented the wheel. As the topic came up among us the other evening I did a little superficial research. All I was sure about was that the English firm of refiners, Carless, Capel and Leonard invented the name 'petrol' for what was commonly called motor spirit here and gasolene in America, happily adapted from 'petroleum' which means 'rock oil'.

First chemical research into the properties of naphtha—a petroleum product—was by the Frenchman, Vauquelin, in 1817 but the existence of petroleum has been known for some couple of thousand years. The Chinese found it seeping through the ground,



it was known in Rangoon, and in the Caucasian valleys. It is also thought the famous but somewhat mysterious Greek Fire was the first use of petroleum as a primitive napalm in war at sea and against fortifications. The Franciscan friar, Roche d'Allion, reported oil in Canada in 1629. Oil springs were familiar in Pennsylvania, Ohio, West Virginia, and Kentucky well before the end of the eighteenth century.

In 1847 a Manchester man named Binney and a partner named Young were in business refining paraffin from a source near Alfreton in Derbyshire. In 1855 petrol was being refined and sold in Pennsylvania. The first artesian well was drilled in Oil Creek, in that State, in 1859 and began to spout at 36 feet. Three years later the district was producing 35.5 million barrels per year.

What was saleable was paraffin, paraffin wax, oil for lubricating machinery, steam and gas engines, and the like, and the big demand was for lamp oil. The petrol produced by their primitive cracking was either thrown away or bottled as a Liniment or to be drunk as a medicine, a cure-all from colic in horses to baldness in men. Some of the lamp oil exploded from time to time.

All this a good 20 years before Benz and Daimler almost simultaneously ran their first engines. Benzole, by the way, is not named after Karl Benz but after a German chemist of Berlin.

*Rodney Walkerley - Safety Fast, Sept 1968*



## New Members

We would like to welcome these new members and look forward to meeting them at our various activities.

John Langford & Dale Knapp  
Yvonne Hatchard

Wellington  
Otaihanga, Paraparaumu



# 31st MG Classic - November

There was plenty of action at this year's MG Classic Motor Race Meeting, with quite a number of MG's and club members competing. While the weather on Saturday was constant rain in Wellington, those that took the trek north were rewarded with fine



Andrew Walburn - MG BGT V8



Ray Hartley - MG F



Graeme Collett - MG BGT V8



Anthony Christenhusz - MG BGT V8



Evan McCarthy - MG F



Grant Kern - MG TD





# 31st MG Classic - November

weather all day at Manfield. Enjoying the sights and sounds from the Toyota Suite. A most enjoyable day.

*Dean Gray*



Brian Ax - MG TF



John Palmer - MG BGT



Bruce Gerring - MG BGT



Greg Haines - MG TD



Geoff Brader - MG TF



Nick Wilcox - MG Midget



# 31st MG Classic - November



Andrew Fox - Jensen Healey



Terry Collier - BMC Huffaker Mk2



Marvyn Towers - MG BGT



Cox boys - Regalia



Ross Armstong/Bill Denize - Pacer



Classic MG T Action



Watch a handicap race from Grant Kern's TD  
<https://www.youtube.com/watch?v=R XKJ147g2gw>



## Auction - Carroll Shelby MG TC

Auction - Scottsdale 2015  
 Status - Sold  
 Price\* - US\$539,000.00  
 \*Includes Buyer Commission  
 Lot - 2510  
 Year - 1949  
 Make - MG  
 Model - TC

Style - Roadster Race Car  
 VIN - XPAG9042  
 Exterior Color - Green  
 Interior Color - Green  
 Cylinders - 4  
 Engine Size - 1250CC  
 Transmission - 4-Speed Manual



### Description

Lot #2510 - The first car that Carroll Shelby drove in a road race — the car that started his racing career.

In May 1952, his good friend Ed Wilkins let Carroll Shelby drive this MG TC in a road race at Norman, OK. It was Shelby's first sport car race. He won it and the second race too, easily outrunning the Jaguar XK120s. That race and this car changed the course of his life, as he went on to achieve immortality as creator of the Shelby Cobra and Mustang, as well as other significant cars.

This vintage race car was part of the famous Syd Silverman Collection for 20 years before being purchased by Ron Pratte. It's well known throughout the MG vintage race car circuit. This historical MG was awarded the prestigious Collier Cup in 2005 at the all-MG vintage race in Watkins Glen, NY.

It also sports the original 1250cc 4 cylinder engine that has been built up to 100+hp and is race ready. This was the car nostalgically referred to and extensively talked about in numerous stories and articles, including an interview with Carroll Shelby in the June 2008 issue of Octane magazine.







## MG TC Midget Road Test

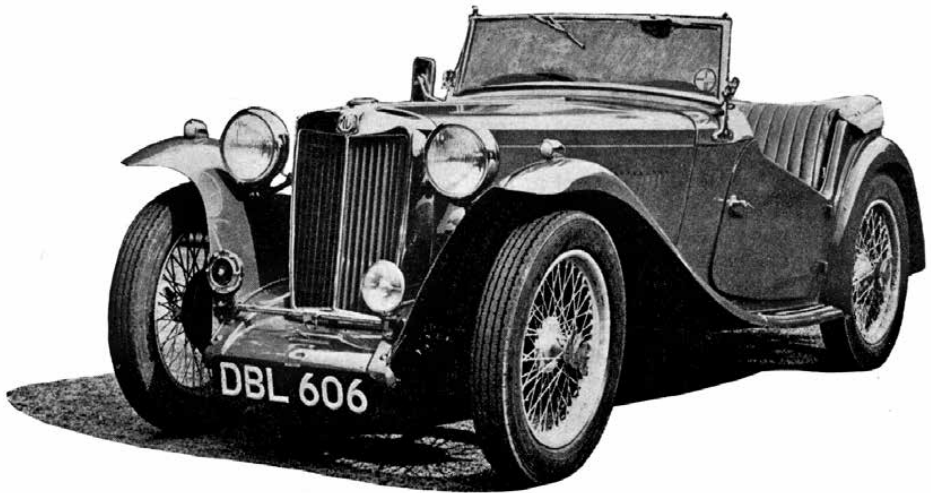

In a motoring world in which there is so much talk as there is today of rationalization, and in which cars tend more and more to resemble one another in appearance as well as in performance for a given size, the M.G. Midget two-seater stands unique. Yet an interesting point, as shown by recent public utterances on export subjects as well as by other sources of information, is that this car does not appeal only to the trials-minded and youthful fraternity of motorists in this country. On the contrary, it is gaining more and more of a following in other countries, including the U.S.A., and has reached a position where it can be regarded as one of our more exportable cars in terms of proportion of total output of the model.

Today it is certainly in a class alone, among cars made anywhere in the world, as a sporting type retaining the conventional outward appearance of the 'real' car dear to the hearts of enthusiasts in years gone by—that is, by displaying its radiator, or at all events a normal grille, and lamps, and in not having gone 'all streamlined'.

It is a model, too, which more than most cars has evolved through the years, with its beginnings in that much smaller Midget of seventeen years or so ago that instantly registered a success. No car has done so much to maintain open-air motoring and to support the demand that exists all over the world for sports car performance and characteristics in a car of not exorbitant first cost and at moderate running costs.

It offers a great deal in sheer performance, yet is not just a sports car with an appeal limited to special occasions; instead it is in every way a perfectly practicable car for all occasions where two seats are sufficient and the fresh-air style of progress is preferred. Actually, the all-weather equipment is good, the hood being easily erected and the side screens likewise, and they turn this car into a very reasonable imitation of a permanently closed car for bad weather use.





## MG TC Midget Road Test

The Midget is in no way more difficult to drive than the ordinary family saloon, but given the type of driver who usually falls for such a machine—not necessarily a youngster—and who likes to use the gearbox, the performance becomes quite vivid. That is not to suggest that the gearbox has to be used in the manner of a pump handle whether the driver chooses or not; the 11-h.p.-rated engine that the 'TC' Midget possesses has quite a range of flexibility on top gear, and the car is tractable in traffic. On the other hand, with an engine that will rev. very freely without complaint much more can be made of the performance, of course, by using indirects that offer maxima as high as 60 m.p.h. on third and 40 on second.

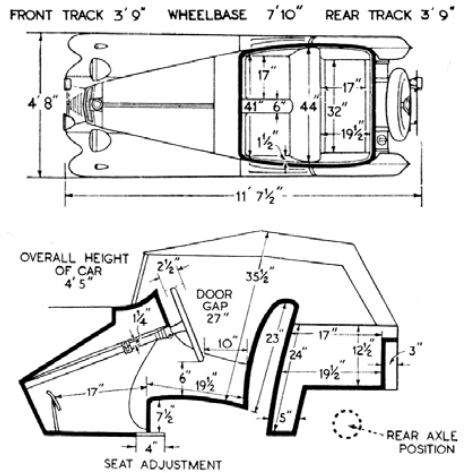

Owing to the handy size of this car, its ability to pass safely where a bigger car would be held back, and the way in which it regains its cruising rate after it has been checked by other traffic, the Midget is almost as fast a car, over British roads, as can be found today. One feels, too, from its ability to take hard treatment and to hold speeds between 60 and 70 m.p.h., apparently for as long as roads in this country permit such motoring, that stretches of motor road offering far more opportunity of sustained speed than ever is found in this island would not 'melt' a Midget engine.

The handiness of the car, the way in which it helps the driver in its manner of cornering, its 'quick' steering, are big factors in giving it unusual average speed capabilities without an extremely high maximum speed being attained. The present car has been handled over a considerable distance in conditions which provided crowded roads, and also over routes on which traffic had been thinned by seasonal and petrol considerations. In both circumstances the average speeds were exceptional, a 40-miles-in-the-hour showing seeming always to be within its reach on a journey of any length, while, when roads are clear, figures such as 44 and 46 m.p.h. averages have been obtained. When the car was being timed by The Autocar's electrical speedometer to be travelling at 75 m.p.h., the car's speedometer showed only 73: an unusual state of affairs. In other more helpful road conditions subsequently the car's speedometer was seen at the 75 mark.

### SENSE OF ACCURATE CONTROL

Always one has the feeling of being able to make a fast run easily in the Midget, for it responds so readily to all the controls and is so quick—eager, it seems—to get moving. The biggest factor in this and other directions, apart from the actual performance available, is the complete sense of command which the driver feels he has over the car at all times, including the major features of brakes, steering and road-holding on corners. The



## MG TC Midget Road Test

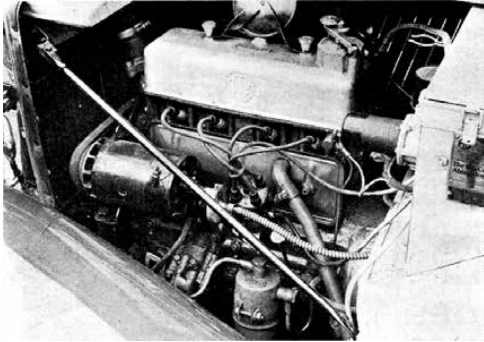

With a hinged-down-the-centre bonnet and normal wings, it is easy to reach the engine, and accessibility of the individual components that require periodical attention is well above the average of present-day standards.

Lockheed brakes deserve special mention, for they deal most effectively with high-speed braking, and also are powerfully smooth in low-speed applications.

Merits and demerits of normal versus independent suspension can be argued, in the main to the latter's marked advantage, but there is no doubt of one fact in this connection. The normally sprung car, rather hard sprung, as in this instance, does let the driver gauge within close limits the speeds at which he can corner safely fast. After a little experience of it one finds oneself holding quite high speeds round bends in the Midget, and the car steering to a close course only a foot or two out from the near-

side verge. Such a half-elliptic suspension has, of course, the counter-balancing feature that it is on the harsh side over poor surfaces, but on the Midget this tendency is by no means excessive.

It is a trim and appealing little car in its general arrangement and very practically laid out, besides offering a considerably higher accessibility factor than is usual today. One quickly comes to feel an affection for its efficiency and willingness, and in all respects, including performance, it is 'man-size', with no suggestion of the tiny car about it.

### DRIVING POSITION AND CONTROLS

Doubly important in a car of this type is the driving position. The Midget is provided with an adjustment for the seat back rest, which is in one piece, although there are two separate cushions, whilst also the spring-spoked steering-wheel is telescopically adjustable and can be placed ideally for full power of control. A feature much appreciated or disliked, according to the point of view, is the fly-off type of hand brake lever—in The Autocar's view a form of control to be highly commended for its certainty and positiveness of operation. A more comfortable position for the left foot off the clutch pedal would be welcomed.

The gear change has synchromesh on second, third, and top, and with a short vertical lever, which is well placed, this works very well for really quick upward and downward changes when the utmost is being made of the performance potential. The instruments include a rev. counter, and the engine can be taken round to 5,500 r.p.m. with celerity, and it will readily go beyond that figure.

One does not think of this car in the usual way in terms of top gear climbing ability. Actually, however, the capabilities in this direction are good, for the power-to-weight ratio is favourable, but it is a delight to drop to third and fly over the gradients that bring the



# MG TC Midget Road Test

speed down at all appreciably on top. As to steeper gradients, second gear lets the car tear up a hill of 1 in 64 calibre.

The headlamps are good for fast night driving. Starting from cold is immediate, and not much use of the mixture control for the twin S.U. carburetters is needed before the engine will pull properly. An excellent point, of value here, but still more so in territories where filling facilities are widely spaced, is the big petrol tank, giving a range of action of approximately 400 miles.

*The Autocar - 17 October 1947*  
 Reprinted 'Safety Fast' October 1959

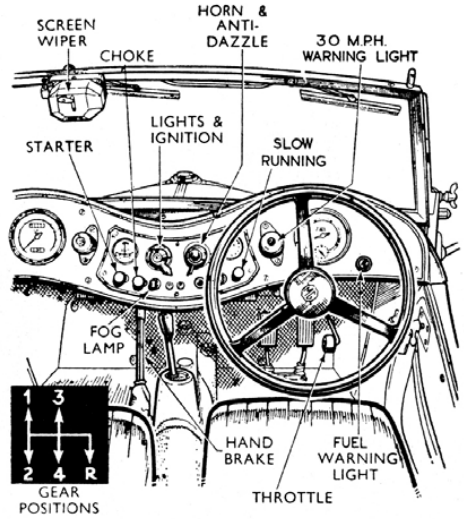

**INSTRUMENTS AND CONTROLS**

### DATA FOR THE DRIVER

TC M.G. MIDGET.  
 PRICE, with open two-seater body, £412 10s. plus £115 6s 8d purchase tax.  
 Total, £527 16s 8d.  
 RATING: 10.97 h.p., 4 cylinders, overhead valves, 66.5 x 90 mm, 1,250 c.c.  
 TAX (1947), £13.  
 BRAKE HORSE-POWER : 54.4 at 5,200 r.p.m. COMPRESSION RATIO: 7.25 to 1. WEIGHT, without passengers: 16 cwt 19 lb. LB. PER C.C.: 1.45.  
 TYRE SIZE : 4.50 x 19.0in on knock-off wire wheels.  
 LIGHTING SET : 12-volt. Automatic voltage control.  
 TANK CAPACITY: 13 1/2 gallons : approx. fuel consumption range, 28-34 m.p.g.  
 TURNING CIRCLE : 37ft (l. and r.). MINIMUM GROUND CLEARANCE: 6in.  
 MAIN DIMENSIONS: Wheelbase, 7ft 10in. Track, 3ft 9in (front and rear). Overall length, 11 ft 7 1/2in ; width, 4ft 8in ; height, 4ft 5in.

ACCELERATION	From steady m.p.h. of		
Overall gear ratios	10 to 30	20 to 40	30 to 50
5.125 to 1	12.1 sec.	13.5 sec.	14.9 sec.
6.93 to 1	8.9 sec.	9.5 sec.	10.4sec.
10.00 to 1	6.2 sec.	6.6 sec.	-
17.32 to 1	-	-	-

Steering wheel movement from lock to lock: 12/3 turns

Speedometer correction by Electrical Speedometer:  
 10 (car speedometer) = 7; 20 = 22; 30 = 29; 40 = 41;  
 50 = 50; 60 = 59.5; 70 = 70.

Speeds attainable on indirect gears

From rest through gears to :-  
 30 m.p.h - 5.7 seconds  
 50 m.p.h - 14.7 seconds  
 60 m.p.h - 22.7 seconds

( by Electrical Speedometer ) -	M.p.h.
1st	(normal and max.)
2nd	15 - 25
3rd	32 - 40
	52 - 61

WEATHER : Dry, warm ; wind light.

Acceleration figures are the means of several runs in opposite directions.

Current model described in 'The Autocar' of October 12, 1945.



# Old Speckled Hen Run – November

## End of Year BBQ – Thursday 24th November

Some 23 people attended the BBQ at Michael & Elaine Anderson home in Waikanae on Thursday the 24th November 2016 starting at mid-day. Some of our usual supporters unfortunately were unable to attend which would have meant the numbers exceeding 30. Not bad for an event held during the week and suggests the OSH activities are an important part of the clubs overall offering.

People attended included Bill & Rae Denize (it was good to see Rae up and running after her mishap in Gisborne), Scott & Joan Stephenson, Murray & Trish Cardie ( who are going to be new members having bought the late Bill Pyne's lovely MG F Abingdon), Gary & Heather Wall from Martinborough, Valerie Hellberg, Rob & Sandra Illingworth from Palmerston North, Lox & Lynne Lummis, Ron Mitchell & Shirley Kelly, Gay Baxter, Richard & Belinda Whitehead, John & Viv Eames from Mangaweka & Helen Gillbanks. We also had apologies from Mary & Graeme Wilson, Andrew & Jill Weeks & Les & Chris Newman.

The weather was fortunately kind to us so we had the opportunity to also sit outside which made for a pleasant BBQ and everyone must have enjoyed themselves as the majority didn't leave until after 4pm!!!!

Michael thank everyone for coming and indicated that next year the programme would again include a 7 Day Tour – this time to the West Coast of the North Island including the Forgotten Highway and starting on Thursday the 23rd October 2017. We already have 6 people confirming they are coming. Additionally he advised the first activity for 2017 would be on the 23rd February 2017 with a run to Murrayfield Langdale Café & Restaurant for the usual planning session and kindly organised by Scott & Joan Stephenson.

*Michael Anderson*



Ron Mitchell, Rob Illingworth, Viv Eames & Valerie Hellberg enjoying fantastic food and conversation



Joan Stephenson, Trish & Murray Cardie (who have bought the late Bill Pynes MGF Abingdon and are going to become members) Michael Anderson - coming out to offer more fantastic food.



# Graeme Tulloch

## Tulmac

### CARBURETTOR SPECIALISTS



in association with 'Auto Classics'

Offers the following services for your 'CLASSIC VEHICLE'

- **Full carburettor re-conditioning and tuning service**
- Specializing in 'SU', 'Stromberg', 'Weber', 'Dellorto', etc.
- Servicing and repairs for your classic MG and other marques.
- Rover V8 conversions.
- 40 years plus trade experience.
- Very competitive rates (projects by negotiation)
- Free pick-up by arrangement.

Contact 'Graeme' on

Mobile: 0276122312 Home: (06) 368 2202

e-mail: [tullochfamily@xtra.co.nz](mailto:tullochfamily@xtra.co.nz)





## MGB LE Rebuild - Part 2

### 1979 MGB LE Rebuild - Part 2. Rust Removal & Prevention, Panel Preparation

The goal: Completely restore the car to like new condition (except engine and drivetrain) in time to attend British car day at Trentham Park on 12 February, 2017.

So the dismantling of the car began on the night of Monday 22 August as Helen and I finished the last of some very wonderful, hoppy homebrew tapped from our 'beer-0-later' located nearby in the next bay of the garage. Each day for the next two weeks parts of the car were removed 'tagged and bagged'. Any parts deemed unfit for refit were put on the 'new parts order list' for purchase from Moss Motors US.



Michael & Helen celebrate



The car in Stokes Valley

On Saturday 10 September after a week of non-stop rains I was finally able to tow the car to a shop in Stokes Valley for rust removal and proofing. I had underbody rust proofing applied to the car upon purchasing it brand new from the dealer and as a result most of the rust to be found was surface rust with the exception of the lower right rocker panel which was to be replaced. Besides the rust removal I had other minor body work to be done like filling in the antenna hole on the front fender since I plan to install a high-gain internal radio antenna.

I left for the States the next day for a six week visit with family and to compete in the Albuquerque International Balloon Fiesta. While in the US I ordered a brand new set of Limited Edition road wheels to be delivered to Pennsylvania where a container bound for NZ was being packed with a WWI airplane for restoration by The Vintage Aviator Limited (TVAL) located here in Wellington. On departing Houston, Texas for Wellington we presented Air New Zealand with six pieces of luggage weighing exactly the maximum allowable per piece. Four of the bags were packed solid with Moss parts for the restoration. Fifteen hours later we arrive home to Wellington on Tuesday 18 October. The next day I'm off to Stokes Valley to see the car that was to now be free of rust, future proofed and ready for relocation to the painter. Upon my arrival and to my disappointment I was informed that little during my six weeks away had been accomplished. I had originally been promised the car would be completed during my time away and would be ready for pickup on my return. The job ended up costing 25% more than the amount agreed between the



## MGB LE Rebuild - Part 2



Rust cut out of rocker panel



the repaired rocker panel

parties and I was now behind schedule for the painter. Bummer!

On 04 November the car was finally ready for pick-up and transferred to the painter in the Upper Hutt. The painter's usual business is high volume sign making but on rare occasions he can be cajoled into putting to use his high-tech spray booth and 25+ years of custom painting skills to work on motorcycles and classic cars for which several have been featured in NZ's top auto magazines.

On 15 November I returned to 'the paint shop' to see how things were going. Wow! The bonnet, boot lid, front fenders, doors and other body pieces had already been painted and given a clear coat. The finish looked stunning even though cutting of the clear coat was still to be done. I must admit I was a little emotional upon seeing these few pieces completed and being reminded of how beautiful the car looked back when she was brand new 37 years prior.

The entire car is scheduled to be completed and ready for pick up from 'the paint shop' before Christmas and the container with the new wheels is also scheduled to arrive Wellington 23 December. So there's still a chance that we might just make it to British Car Day... Stay tuned!

*Michael Shouse*





## Tech Talk - MGF Fuse 1

### MGF Fuse Box Maladies

It was a rainy evening, in fact it had rained nearly all day, standing water on the roads and it was a club pub night at one of our member's local.

This particular pub night was in a tiny village in Huntingdonshire and it was billed as 'Gastro Pub of the Year' so it was bound to be good. I thought the rotten weather would keep the turn-out low, but over 20 of us turned up and the food was certainly very good.

I had been thinking whether to take our 2001 MGF but decided to take it despite the rain. All was well during the journey to the pub, but the return home was to prove difficult.

I left the pub early and the car started perfectly well, headlights, wipers, heater fan and radio all turned on, the first sign of trouble was a loud crack through the radio loudspeakers and the radio went off momentarily but came back on. I turned it off. Driving along the narrow single-track lane at no more than 15mph the MGF had a total and unexpected failure of all lights, engine stopped and it was pitch dark. My eyes took a few seconds to adjust to complete darkness and after a low speed emergency stop luckily the car was still on the road.

My first thought was that this lane has road signs warning of 'Bends for One Mile' and someone could come around the bend and not see my stationary car. However seconds later everything came back on again, the engine was restarted and my journey resumed.

I noticed the lights on the dashboard dials were flickering irregularly and I considered stopping the car at the next village under a street light to investigate but the car was still going. Best to leave it until I got home.

I put the car in the garage and took a look and feel under the bonnet, I almost burnt my hand when feeling the underneath fusebox, the one close to the battery. At least I knew where to look in the morning.

I removed the fusebox, took the covers off and the fault was obvious, the heavy duty cable tail from the battery to the fusebox is fixed to the fusebox by a screw, the screw was loose and the surrounding area was melted and burned. The fusebox was a total loss and as I tried to tighten the screw it just span in the hole.

The damage was so bad I had to consider if the offending screw was loose from manufacture or worked loose over time. I suspect that as the nights are growing longer, headlights, wipers, heater and for good measure radio on combined to accelerate the failure.

Looking at the fusebox on the bench there is no external signs outside but take off the covers and the burning is plain to see.

I fitted a replacement, checking all screws first and all is well.

I consider the episode a lucky escape, I had just filled the fuel tank, put the car in an







## Tech Talk - MGF Fuse 1

integral garage and it was clear to me a fire could have started at any time.

It isn't the kind of thing that one inspects routinely nor expects to happen, I don't think I have ever checked a fusebox as a routine matter but it is probably worth a look inside from time to time as MG F are ageing and especially as the fault can be catastrophic.

*John Riley - Enjoying MG, November 2015*



## Tech Talk - MGF Fuse 2

MGF (2001 on) and MG TF Alternator Fuse For the 2001 model year MGF and which was carried through to the TF, MG chose to add extra fuse protection to the alternator circuit with an 80 amp fuse located in the centre of the rear engine bay bulkhead. Not all owners are aware that this fuse exists and whilst it very rarely blows, it is always worth checking the fuse before assuming it is an alternator failure. After all a maxi blade fuse costs less than approx. £1.50 against well over £100 for a replacement reconditioned alternator. The first image shows where the fuse is located in the engine bay under an opaque plastic cover that very effectively hides it even when the boot to engine bay grille is removed.

*Roger Parker - Enjoying MG, December 2015*



## Driver Training Day - January

The MG Car Club Wellington Centre runs a Driver Training Day on Wellington Anniversary Monday at Manfeild each year. **There is a driver entry fee, \$80.00.** The day is open to all members and invited friends aged 12 years and over. The day features two levels of activity:

### 1. Mornings

- In the morning you can drive your car around the circuit at road speeds
- There is no passing allowed on corners although you can pass other cars on the straights
- You can opt to have an experienced track driver with you to give you tips on how to handle the track at speed

### 2. Afternoons

- If you are feeling a little more confident after the morning's run you can drive a little faster in the afternoon
- The runs are non-competitive
- You will need a helmet
- Roll cages not required



# MG T-Series Heaven

## MG T-Series Heaven, La Grange, Texas



101 miles west of Houston, Texas lies a little 'cow town' of a place named La Grange, Texas. Usually a quiet little place La Grange became famous for its little brothel just outside of town known as the Chicken Ranch. It closed in 1973 after the band ZZ Top attracted international attention to La Grange with its classic rock song titled "La Grange", which referred to "that shack outside La Grange".

A few years later after things quieted down again a fella named Bill Jones moved into town. He set up a nice little respectable business on West Travis Street, the main drag through town. He had a thing for vintage MGs. In fact, he was and still is very passionate about them. Over time he amassed a HUGE collection of T-series cars and parts. Shelves and shelves and shelves of parts. If you owned a T series MG, lived within a thousand miles, needed parts or service or someone to take away 'free of charge' your dead husband's car that had been sitting in the barn for decades, Bill was your man.





## MG T-Series Heaven



My sister Dawn lives on the other side of Texas and she and her husband were driving through La Grange several years ago to go camping out west and noticed Bill's shop. (Thanks to my Dad we were raised to spot anything that smelled like or looked like it had anything to do with MGs.) So I got in my little plane one day several years back and flew over to La Grange and couldn't believe the enormity of what I was looking at. Unfortunately my plane wasn't big enough to haul back everything I wanted to buy for my MGTf project.

I more recently began to think about getting back onto my 'TF' project and to give Bill a visit while in Texas this past October. So I, Helen and her son Connor loaded ourselves into the little plane again and flew out to La Grange. In more recent times Bill's health has started to fail him. He's eighty-something now and hasn't any family to pass his business on to and it's not the kind of business that a 'local' in La Grange would have an interest in. So Bill is rapidly selling everything off, mostly through eBay with the help of a more computer literate helper. However, if you can make your way to his shop in La Grange, a truly exciting experience is in store and Bill's 'cash and carry' prices are 'low down'. There's that one catch, you need to have cash to make a purchase. But that's not a problem cause Bill is right across the street from a bank with an ATM. This can be a very dangerous thing unless you flew to La Grange in a small plane with two other people!

It was a great visit and a pleasure to see Bill. We made some great buys on TF bumpers, grill parts, etc. Bill took a shine to Helen and her interest in his 'museum-like' office and she came back with some very nice little MGT novelties herself and didn't spend a dime. We just managed to get the plane off the ground departing Fayette Regional Airport.

If you'd like to pursue anything 'T series' from Bill his business name and address is Bill Jones' Vintage Sportscars, Ltd., 339 West Travis Street, La Grange, Texas 78945.

Bill doesn't use email so you'll need to give him a call at 001 (979) 968-6937.

*Michael Shouse*





# MG ZS Revealed



The all-new 2017 MG ZS has been revealed, representing a styling and technology step beyond the company’s first SUV – the mid-sized GS, revealed late last year.

Importantly for the company’s Australian operation, recently under new management, the ZS will come here late next year as a crucial new offering in the country’s best-selling market segment.

The ZS introduces what will likely become a new corporate look for the MG brand, aping the merged grille-to-headlamps look now trending with the likes of Audi, BMW, Kia and Mazda – the latter potentially a direct inspiration for this new SUV’s face.

A key point in MG’s unveiling announcement was the ZS’s internet-connected user functions, allowing individual drivers to log into the vehicle’s system and control various features by voice alone.

“The MG ZS also uses natural semantic technology, which allows users to open and close the sunroof, regulate the temperature, playback music and request navigation, all by a simple oral command – hands free to allow drivers to focus on driving, ensuring a safer ride,” the company says.

A panoramic sunroof was also highlighted, measuring 1365mm long and 870mm wide, with a 695mm opening space.







## MG ZS Revealed

A look at the ZS SUV's interior is still to be offered, and the blacked-out windows of the cars on display suggest MG has not finished with that aspect of the car's design.

Reports overseas suggest the ZS is based on a shortened version of the GS SUV's platform, but the company has yet to confirm details of its architecture.

A new 1.0-litre direct-injected and turbocharged NetBlue '16T' petrol engine will provide power, offering 93kW and 170Nm of torque. Reports out of the UK suggest the GS SUV's 122kW/250Nm 1.5-litre unit could also appear in the ZS.



Speaking with British website Auto Express this week, MG marketing chief Matthew Cheyne said that while SUVs are new to the badge, the segment's huge popularity meant makes it one that very few brands can ignore.

Mike Stevens - [www.caradvice.com.au](http://www.caradvice.com.au)

### PAUL WALBRAN MOTORS

Importers, stockist & distributors of quality new MG parts

17 Brownie Rd, Laingholm, Auckland 1007

Ph 09 817 8194 Fax 09 817 8164 Mobile 021 886 723



### THE PARTS SPECIALIST

- Helpful advice based on 30yrs MG experience
- Prompt service • Low prices



**We can help with all MG models**

**Phone now for your copy of our  
FREE illustrated catalogue.  
Price List Included**



## Buried MG



Rare car buried under a Gloucestershire shed wins an award

A rare two-seater car found buried under a cowshed in Gloucestershire has won a Best Vintage Car award.

All the parts of the 1928 MG MK IV Sports car were found in 1999 on a farm “carefully dismantled” and laid in the ground under two inches of concrete.

Fred Body, from Cheddar in Somerset, has spent over a year painstakingly rebuilding the early MG.

He said: “It’s weird really - most of it was there and most of it was as sound as a pound.”

According to the Early MG Society, only 135 examples of this model were made in 1928 and this car is the sole survivor in the country that displays the correct coachwork.

“When it was found it was completely taken apart, laid out flat and covered in gravel and one or two inches of concrete,” said Mr Body, a car enthusiast who bought the parts when the owner put them up for sale.

### **Wartime secret**

“I think what must have happened was the war was coming and someone thought ‘they’re not taking my car for scrap’.

“They carefully took it apart and buried it thinking they would come back and put it together again.”

All the major parts of the car were found preserved under the concrete base of a cowshed

It was only when the shed was pulled down and the floor dug up that the car was discovered with all its identification including Guarantee plate and original number plates.



## Buried MG



“Some of the original leather from the seats and paint work was there so we could colour match it as near as possible,” said Mr Body.

“But some of the aluminium had corroded where I think the concrete had cracked and urine from the cow house had got in.

“And all the instruments were missing - they probably adorned someone’s fireplace - so

they were the most difficult to find.”

At the end of April the resurrected car won the Best Vintage Car award at the 2012 Bristol Classic Car Show.

A spokesman for the Early MG Society said: “There is no history on this car until 1999 when it was miraculously ‘discovered’.

“It is now one of the few genuine MGs that has come to light in the last 25 years - it’s been a real “from the ground up” restoration.”

*bbc.com*

*Photographs: Early MG Society*



## Noggin N Natter - March

### **MG garage visit & quilting session - Sunday 12 March.**

This will be a David & Kate Hector’s place.

6 Richmond Rd, Mahina Bay, Eastbourne.

Afternoon, time to be confirmed, please bring a plate.

Time & details will be confirmed by email.

If you want to nominate your garage for a club visit please contact Michael Shouse.

Contact: Michael Shouse - email: [upnzway@earthlink.net](mailto:upnzway@earthlink.net)



## Tech Talk - Pozidriv

The other day I was talking to an 'MGB' owner who complained about the cross-head screws used widely in his car. 'I don't like them', he said. "These Philips screws burr their heads too easily if they are at all tight and once the recess is damaged, my Philips screw-driver won't shift them. Why don't they use ordinary slotted screws?' He was amazed when I explained that Philips screws have not been used generally in BMC cars for several years now. The cross-head screws used in his 'MGB' are Pozidriv screws and a Pozidriv screwdriver is necessary to fit them properly.

The Pozidriv recess is a development of the Philips and looks very similar, but in fact it is a considerable improvement on its predecessor, particularly when power tools are used under production conditions. The screw-driver point fits better and is less likely to jump out accidentally when rotating —which could be disastrous to any surrounding paintwork ! Ordinary slotted screwdrivers are virtually never used now on quantity-produced 'consumer durables' because they cannot be driven quickly enough without the 'driver slipping out of the slot.

The invention of the Philips recessed-head screw was a tremendous breakthrough and speeded up assembly out of all recognition. Semi-skilled operators can use high-speed power tools without any special training and this all helps to keep down the price of the finished product. The Pozidriv head is a further worth-while step forward. The old Philips screwdrivers can be used to drive Pozidriv screws but they do not fit very well and (as our friend observed) tend to burr the screw-head if much force has to be used. Far better to invest a few shillings (*dollars-Ed*) in a couple of Pozidriv tools (they come in four point sizes) and they will see you right for years.

Pozidriv screws can be readily distinguished from the old Philips type by the extra diagonal marks on the head, shown below.



Pozidriv Head



Phillips Head

All good cross-point screwdrivers have the type (Pozidriv or Philips) and the point size stamped on the shaft (*or the colour of the handle will be different-Ed*).

*Stuart Seager - Safety Fast, February 1968*



Pozidriv



Phillips

Screwdrivers





# Membership Fees

The Membership year is from 1st July to 30th June each year.

Existing members will receive a renewal invoice in the post, usually early June. Those non-members wishing to join the club can do so by following the 'Membership' tab on our Web site: [www.mgcarclub.org.nz](http://www.mgcarclub.org.nz). This will provide a couple of options, including an online form which is the simplest and quickest way for intending members to join the club.

Single \$60 Double \$70 Family \$80

You can pay your renewal on-line direct to our account 03-0539-0165992-00 Please it is important you include your membership number and/or name as a reference.

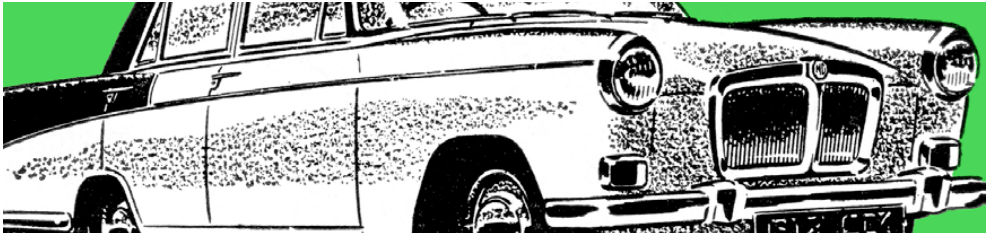

## Ray Hartley Motors

WELLINGTON'S ONLY INDEPENDENT SUBARU SPECIALISTS

**RACE-CAR PREPARATION**

WARRANT OF FITNESS TESTING

**AUTOMOTIVE REPAIRS**

MOTOR GARAGES

**RESTORATION WORK**

RENTAL CARS FOR HIRE

**MG & LOTUS SPECIALISTS**



mta  
ASSURED

OWNED  
AND OPERATED  
**SINCE**  
**1989**



(04) 384 4459

rhm@rayhartleymotors.co.nz

[www.rayhartleymotors.co.nz](http://www.rayhartleymotors.co.nz)

18 Haining St,  
Wellington





## Grill Badges

The four MG Car Club Centres in New Zealand - Auckland, Wellington, Canterbury and Otago have authorised this new Grille Badge, which has a distinctive NZ flavour with the inclusion of the Silver Fern in the background.

The intention over time is to begin using this badge on communications, regalia and other activities.

61mm x 81mm - **\$50.00.**



Calling all **MG owners**, if you haven't celebrated the birth of your favourite sports car, now is your chance too. We currently have a few remaining MG 90th grill badges available which will enhance your car and sit beautifully alongside other MG Car Club badges, why not collect a set!

75mm - **\$43.00 while stocks last.**



Grill badges can be purchased from

Michael Shouse

phone: **04 297 2279** or

email: **upnzway@earthlink.net**

Rear Cover, 31st MG Classic Motor Race Meeting: Top: Greg Haines MG TD.

Middle: Sybil Lupp Merorial Invitation, Bruce Gerring MG BGT leading, Grant Kern MG TD, Graeme Collett MG BGT V8 and Ray Hartley MG F.

Bottom: Marvyn Towers radical MG BGT V8.

Photographes: Dean Gray.



## Advertising specifications for display advertisements

Prices for 12 months

Full Page                 \$240

Half Page                 \$200

Quarter Page             \$100

Advertisements may be supplied in most common digital formats by e-mail or on flash drives or CD's, etc. Alternatively your raw copy can be turned into suitable artwork for your approval.

Enquires to Dean Gray, Email: [editor@mgcarclub.org.nz](mailto:editor@mgcarclub.org.nz)



# MG Car Club (Wgtn) Regalia



MGCC Lanyard  
Black/white or  
Blue/white  
\$5.00.



1634 - Silverdale, Merino pullover  
Natural mix - S-XL - \$125.00.



WLV - Gear, Women's Vest  
Silver/Black - S-XL - \$65.00.



1634 - Silverdale, Merino pullover  
Navy - S-XL - \$125.00.



LV - Gear, Men's Vest  
Black - S-XL - \$65.00.



MG printed mug, as pictured - \$15.00.



498Q - Gear, Zip fleece  
Navy - S-XL - \$65.00.

MG Car Club regalia can be purchased from  
Michael Shouse phone: 04 297 2279  
or email: [upnzway@earthlink.net](mailto:upnzway@earthlink.net).



